



MOCAPLAS®

MOSQUITO NETS

TECHNICAL DOSSIER





INDEX

01 ROLL-UP MOSQUITO NETS

Roll-up Round drawer M-33	3
Roll-up Round drawer M-35	4
Roll-up Round drawer M-42	5
Roll-up Round drawer P-42	6
Side door system	7
Double Side Door System	8
Frontal System	9
Double Guide	9

02 FIXED MOSQUITO NETS	10
-------------------------------	-----------

03 FOLDABLE MOSQUITO NETS	12
----------------------------------	-----------

04 SLIDING MOSQUITO NETS

Curved sliding profile	15
Large sliding door	16

05 SIDE MOSQUITO NET CHAINS	17
------------------------------------	-----------

06 PLEATED MOSQUITO NETS

Pleated mosquito net 22	22
Pleated mosquito net 40	23

07 COLORS AND FINISHES	25
-------------------------------	-----------

08 FABRICS	28
-------------------	-----------

09 EXPLODED VIEWS	30
--------------------------	-----------

10 MEASUREMENT GUIDE	37
-----------------------------	-----------

SOLUTIONS FOR ALL SPACES



MAXIMUM SECURITY

Total reliability to ensure peace of mind against insects.



HIGH QUALITY

Manufacturing of fabrics and profiles following the strictest resistance standards.



CHROMATIC VARIETY

A wide range of colours that adapts to all types of windows and doors.



VERSATILITY AND ADAPTABILITY

Variety of possibilities for use and installation, ensuring that there is always a product for every need.



ROUND DRAWER M-33



TECHNICAL DATA

Head	33 mm
Maximum recommended width	1500 mm
High Maximum	1400 mm
Tissue	Fiberglass
Drive	Manual
Material in length	Yeah
Ready-made sale	No
Accessories	Optional



M-33 head



Side guide
with doormat



Side anti-wind guide
with doormat



Central guide with
doormat



07

MOSQUITO NET

MOTORIZED

Motorized mosquito nets for windows and doors are the most suitable solution for closing large openings with a single fabric. They can be operated by remote control.

Our motorized mosquito net will allow you to control the movement of raising or lowering quickly. In addition, they have a 76 millimeter square box and a 43 millimeter axis to ensure smooth operation.

Perfect combination of elegance and functionality, made to measure or supplied in length. We can make them up to 3 metres wide.



Vertical Opening



Material in length or ready-made

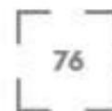

Box measurement

ROLL-UP MOSQUITO NET MOTORIZED



TECHNICAL DATA

Head	76 mm
Maximum recommended width	3000 mm
High Maximum	3000 mm
Tissue	Fiberglass
Drive	Engine with remote control
Material in length	Yeah
Ready-made sale	Yeah
Accessories	Optional

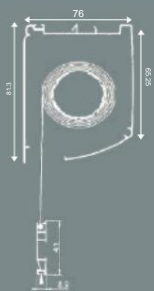

P-76 Head



Side guide with
windproof doormat



Profile clamping
superior

ROUND DRAWER M-35



TECHNICAL DATA

Head	35 mm
Maximum recommended width	1600 mm
High Maximum	1800 mm
Tissue	Fiberglass
Drive	Manual
Material in length	Yeah
Ready-made sale	No
Accessories	Optional



M-35 head



Side guide
with doormat



Side anti-wind guide
with doormat



Central guide with
doormat



01 MOSQUITO NETS

ROLLING BLINDS

It is the most widespread and practical mosquito net system, ideal for all types of windows, as it is quick and easy to install.

The box has a recovery spring inside to provide better winding, and its upper part has a sealing mat that also prevents the possible entry of insects and air currents.

Optionally, a brake can be added that controls the winding of the fabric, slowing down the rise evenly.



Vertical or horizontal opening



Material in length up to 6 meters



Extent
Box

ROUND DRAWER M-42



TECHNICAL DATA

Head	42 mm
Maximum recommended width	2000 mm
High Maximum	1800 mm 2400 mm
Tissue	Fiberglass
Drive	Manual
Material in length	Yeah
Ready-made sale	No
Accessories	Optional



M-42 head



Side guide with doormat



Side anti-wind guide with doormat

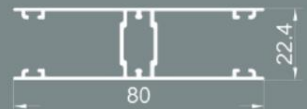

Central guide with doormat

ROUND DRAWER P-42



TECHNICAL DATA

Head	42 mm
Maximum recommended width	2000 mm
High Maximum	1800 mm 2400 mm
Tissue	Fiberglass
Drive	Manual
Material in length	Yeah
Ready-made sale	No
Accessories	Optional



P-42 Head



Side guide
with doormat



Side anti-wind guide
with doormat



Central guide with
doormat

SIDE DOOR SYSTEM



TECHNICAL DATA

System	42mm drawer
Maximum recommended width	1200 mm
High Maximum	2100 mm
Tissue	Fiberglass
Drive	Manual
Material in length	No
Ready-made sale	Yeah
Accessories	Optional

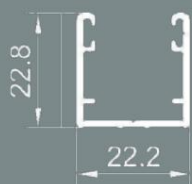

Bottom guide
with doormat



Side guide
with doormat



Side anti-wind guide
with doormat



Closing profile
with magnet

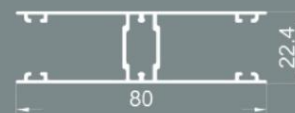

Central guide with
doormat

DOUBLE SIDE DOOR SYSTEM



TECHNICAL DATA

System	42mm drawer
Maximum recommended width	2100 mm
High Maximum	2400 mm
Tissue	Fiberglass
Drive	Manual
Material in length	Yeah
Ready-made sale	Yeah
Accessories	Optional

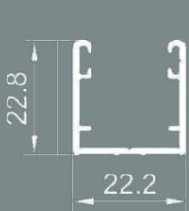

Bottom guide
with doormat



Side guide
with doormat



Side anti-wind guide
with doormat



Closing profile
with magnet

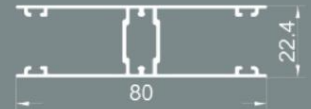

Central guide with
doormat

FRONT SYSTEM

FRO



Available for M42, P42, M35 and M33 system

DOUBLE GUIDE

DOUB



Available for M42, P42, M35 and M33 system



02 MOSQUITO NETS

FIXED

This is the simplest and most economical system, ideal for simple and economical systems that require an installation in which it is not necessary to have access to the outside.

Installation is very simple as the fabric is placed on an aluminium frame, which is easily fixed to the window opening using clips. When not in use, it can be easily removed.



Windows



Custom
manufacturing



Easy
installation

FIXED MOSQUITO NET

Fixed mosquito net profile

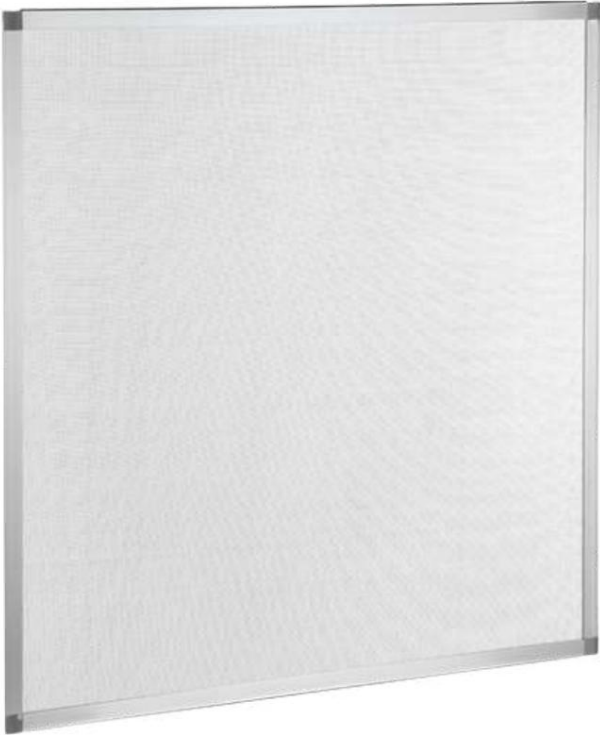
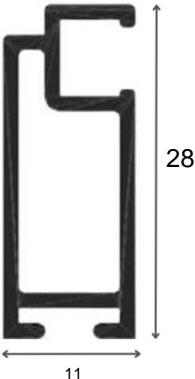

Maximum recommended dimensions

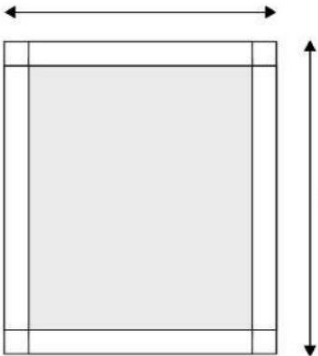

TECHNICAL DATA

Maximum height: 1500 mm

Maximum width: 1500 mm

Straight cut fixed mosquito net profiles

Anchor with support

Fiberglass or aluminum fabric

Possibility of multiple sheets

Supplied to measure or in length



03 MOSQUITO NETS FOLDING DOOR

It is the perfect solution for spaces that lack doors and do not require additional security. It can be manufactured with either a right or left opening.

The outer frame has the option of overlapping or non-overlapping to facilitate assembly and obtain a perfect finish.

Its use, through a folding opening, is simple and comfortable thanks to its knob or handle.



Opening
Folding



Custom
manufacturing



1 or 2 leaves

MOSQUITO NET FOLDING DOOR



TECHNICAL DATA

Maximum recommended width 1 sheet	1200 mm
High Maximum	2500 mm
Tissue	Fiberglass
Drive	Manual
Material in length	Yeah
Ready-made sale	Yeah
Accessories	Optional

*The use of a crossbar is recommended from 190 cm

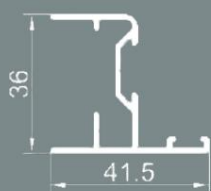

Marco Profile
Forte

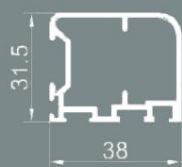

Leaf profile
Forte

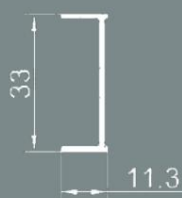

Compensating profile
Forte



Clip Profile
Forte



Central Profile
Forte



04 MOSQUITO NETS

SLIDING DOORS

Easy to use and install, it can be used for windows and doors, adapting to most aluminium carpentry on the market.

It slides smoothly and silently along the interior profile of the carpentry thanks to its resistant bearings. Its outer sealing mat is continuous in the corners, sealing 100% of its contour.



Smooth
glide



Custom
manufacturing



Easy
installation

CURVED SLIDING PROFILE

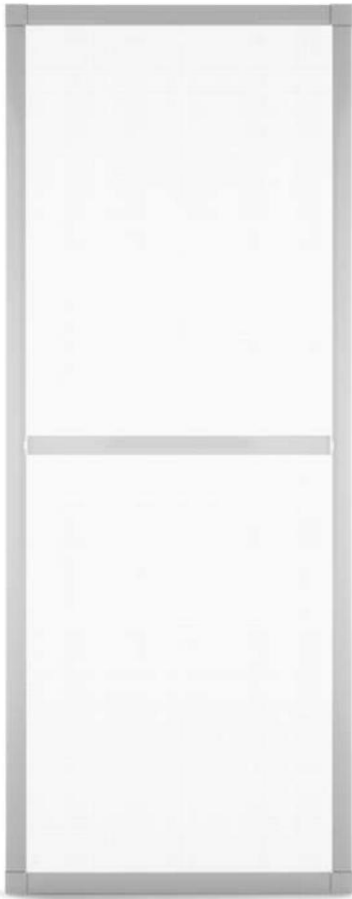

TECHNICAL DATA

Maximum recommended width	180 cm
High Maximum	240 cm
Tissue	Fiberglass
Drive	Manual
Material in length	Yeah
Ready-made sale	Yeah
Accessories	Optional

*The use of a crossbar is recommended from 190 cm



Mosquito net profile curved slide



Intermediate profile curved mosquito net



Mosquito net profile sliding door with doormat



Z profile mosquito net slide

SLIDING MOSQUITO NET LARGE DIMENSIONS



TECHNICAL DATA

Easy to install and use

Smooth gliding thanks to its sturdy skates

Suitable for doors and windows with large openings

Reduced 7mm lower guide. Easy access.

Robust profiles

Possibility of both 45° and 90° angles

Possibility of mounting it with screen or transparent vinyl

Possibility of 1 and 2 sheets

Width 1 sheet: 2400 x 5000 mm



OPENING
SIDE



WINDOWS
AND DOORS



MADE
AND IN LONG



MANUFACTURING
CUSTOM MADE

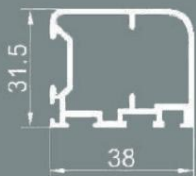

Profile
Slide



Mosquito Net Profile
Large dimensions



Clip Profile
Slide



Lower Profile
Slide



05

MOSQUITO NET

SIDE CHAINS

The chain-operated side screen is an ideal solution for passageways such as doors and windows. Its chain-operated sliding system provides a smooth and functional opening without tension on the system.

With this chain system we will only need a thin plate on the floor as a guide instead of an aluminum profile.

Its installation is really simple and you can choose the opening orientation to make everything as easy as possible for you.



Side opening



Custom manufacturing



1 or 2 leaves

FLAT CHAIN SIDE MOSQUITO NET



TECHNICAL DATA

Guided by lower chain

Without bottom profile

It is collected in a side box

Locking system

Fiberglass fabric

Ergonomic opening profiles

Perimeter magnet in its profiles

	Maximum width	Maximum height
Simple	1500 mm	2500 mm
Double	3000 mm	2500 mm

VARIATIONS OF SIDE CHAIN MOSQUITO NET

2

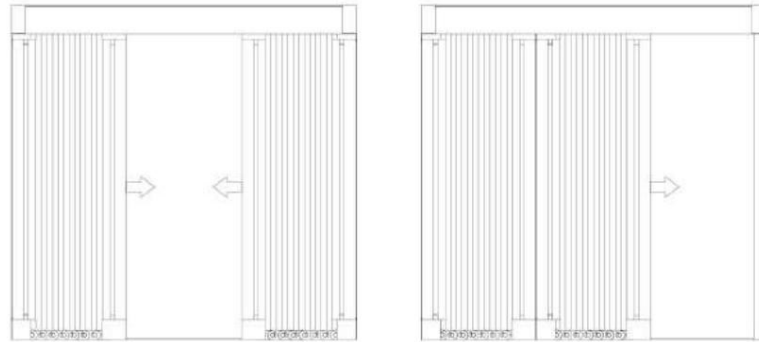

SERI

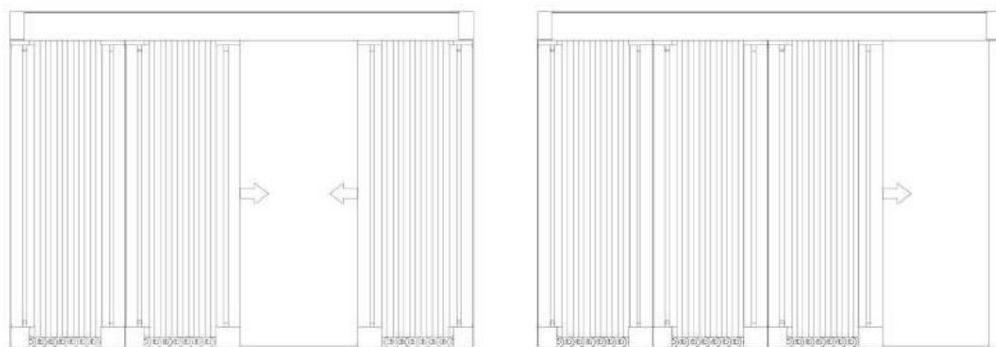



06 MOSQUITO NETS PLEATED

The TWO 22 and FOUR 40 pleated mosquito nets stand out for their unique aesthetics and innovative accordion side-folding system, which provides a very comfortable and smooth closure, allowing the fabric to be stopped at any part of the opening.

Also noteworthy are its magnetic closure, the handle, the profile and the absence of a lower guide or a lower guide lowered by 7 mm, which provides a more accessible passage. It allows the connection in series of several leaves, so that large gaps can be covered.

It is recommended to install it on doors or windows where there is a continuous passage, such as terraces, balconies, patios, etc.



Side
opening



Custom
manufacturing



1 or 2 leaves

PLEATED MOSQUITO NET 22



TECHNICAL DATA

Magnetic closure

Accordion collection system

Handle integrated into the mosquito net

Manufacturing in 1 or 2 sheets

Lower guide lowered by 7mm on the floor

Pleated fabric comes in black as standard. Grey available upon request.

Ready-made sale

Available in 3 models: Side, reversible and double

	Maximum width	Maximum height
Minimum	-	600 mm
Max. 1 Sheet	2400 mm	3000 mm
Max. 2 Sheets	4800 mm	3000 mm

*Dimensions must be transmitted in mm indicating width x height.
The mosquito net will be supplied with the same measurements requested.

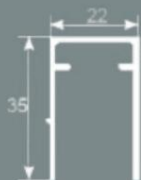

Upper Profile
Pleated

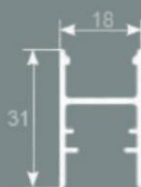

Fixed Profile
Pleated



Mobile Profile
Pleated



Lower Profile
Pleated

PLEATED MOSQUITO NET SECTIONS 22

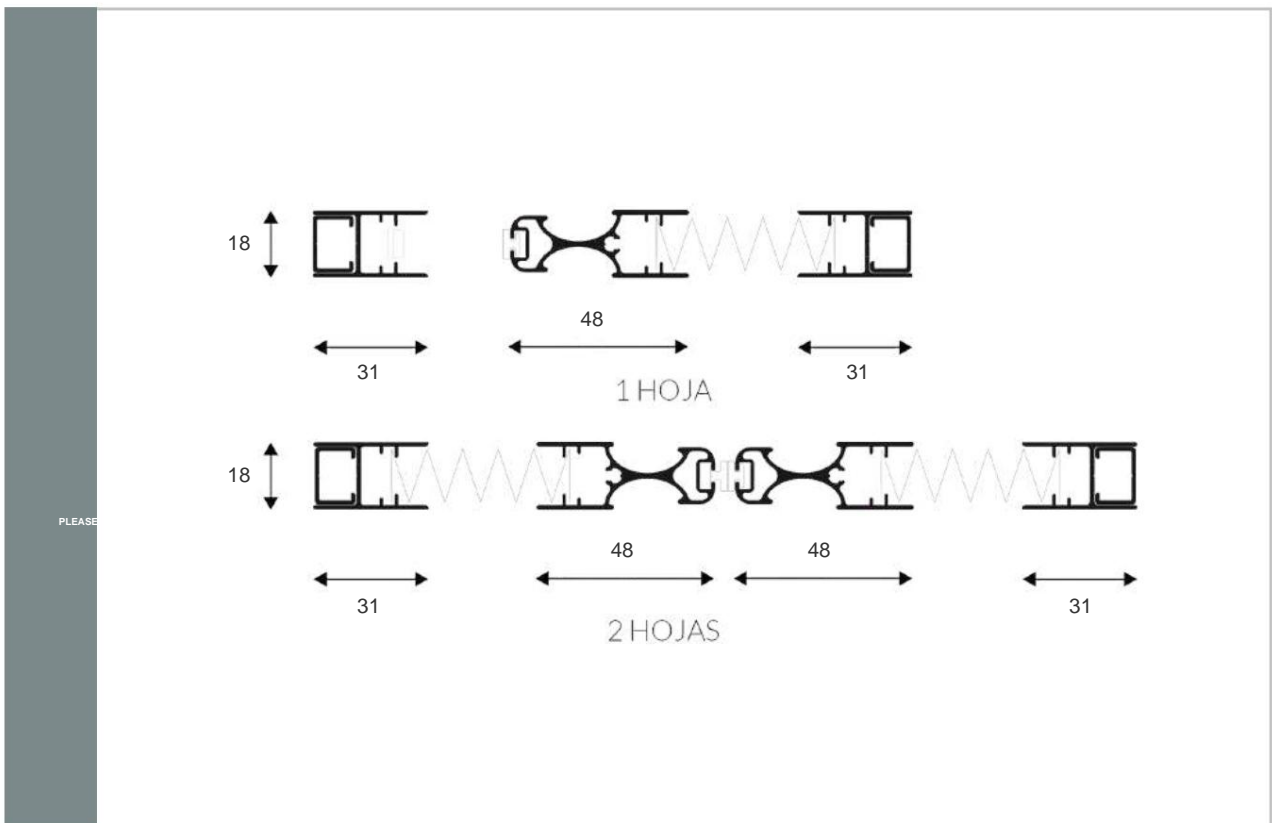
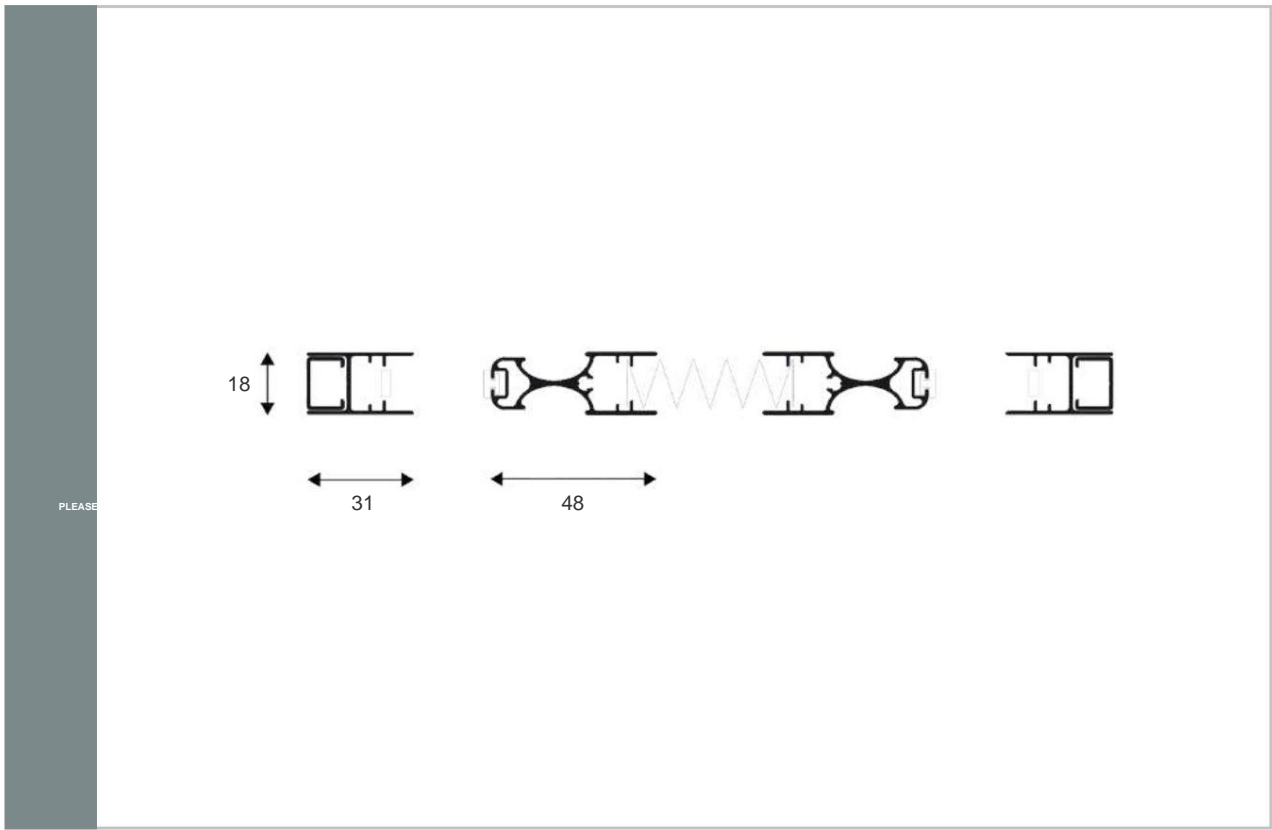

PLEATED MOSQUITO NET 40



TECHNICAL DATA

Magnetic closure

Accordion collection system

Handle integrated into the mosquito net

Manufacturing in 1 or 2 sheets

Absence of lower guide on the ground

Pleated fabric comes standard in Black

Ready-made sale

Allows the serial connection of multiple sheets

	Maximum width	Maximum height
1 Sheet	1900 mm	3000 mm
2 Sheets	3800 mm	3000 mm

*Dimensions must be transmitted in mm indicating width x height.
The mosquito net will be supplied with the same measurements requested.



Upper Profile
Pleated



Closing profile
magnet



Fixed Profile
Pleated



Mobile Profile
Pleated



Lower Profile
Pleated

PLEATED MOSQUITO NET SECTIONS 40

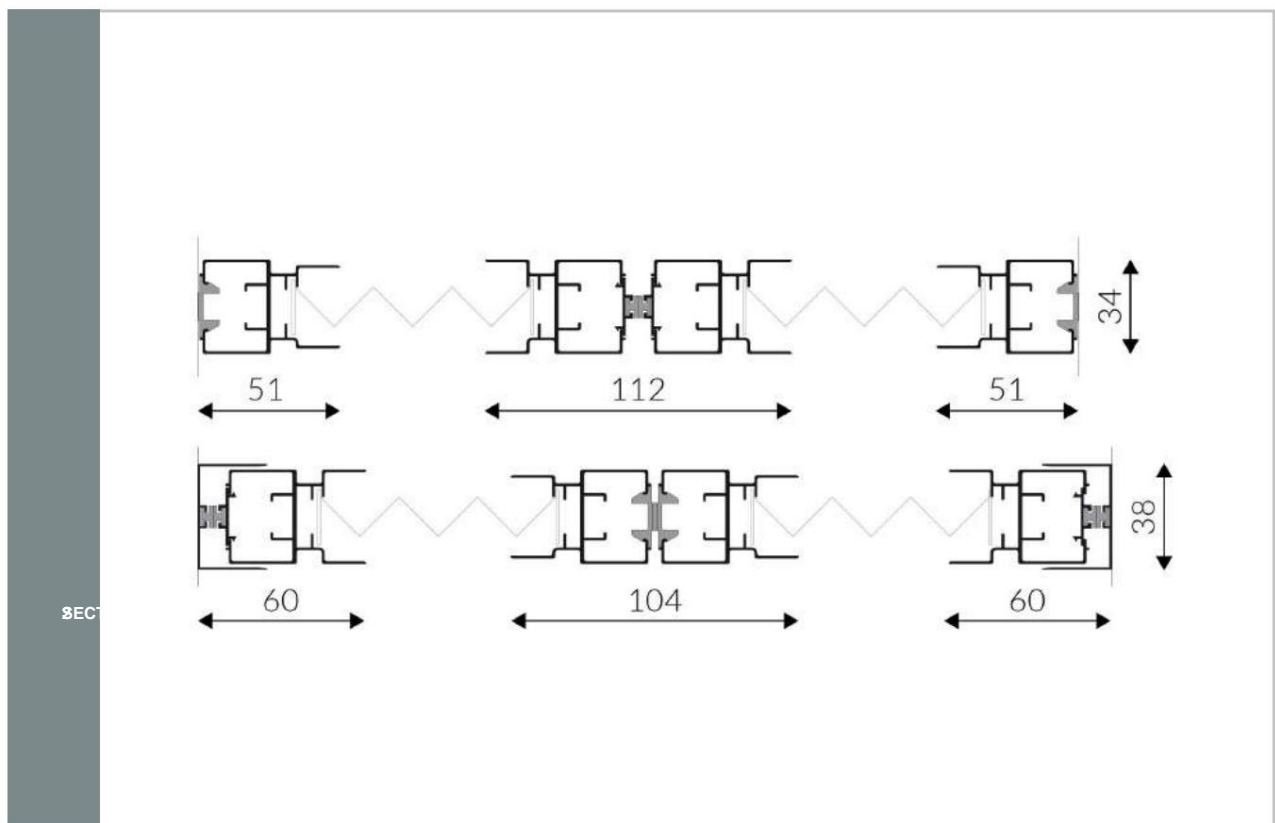
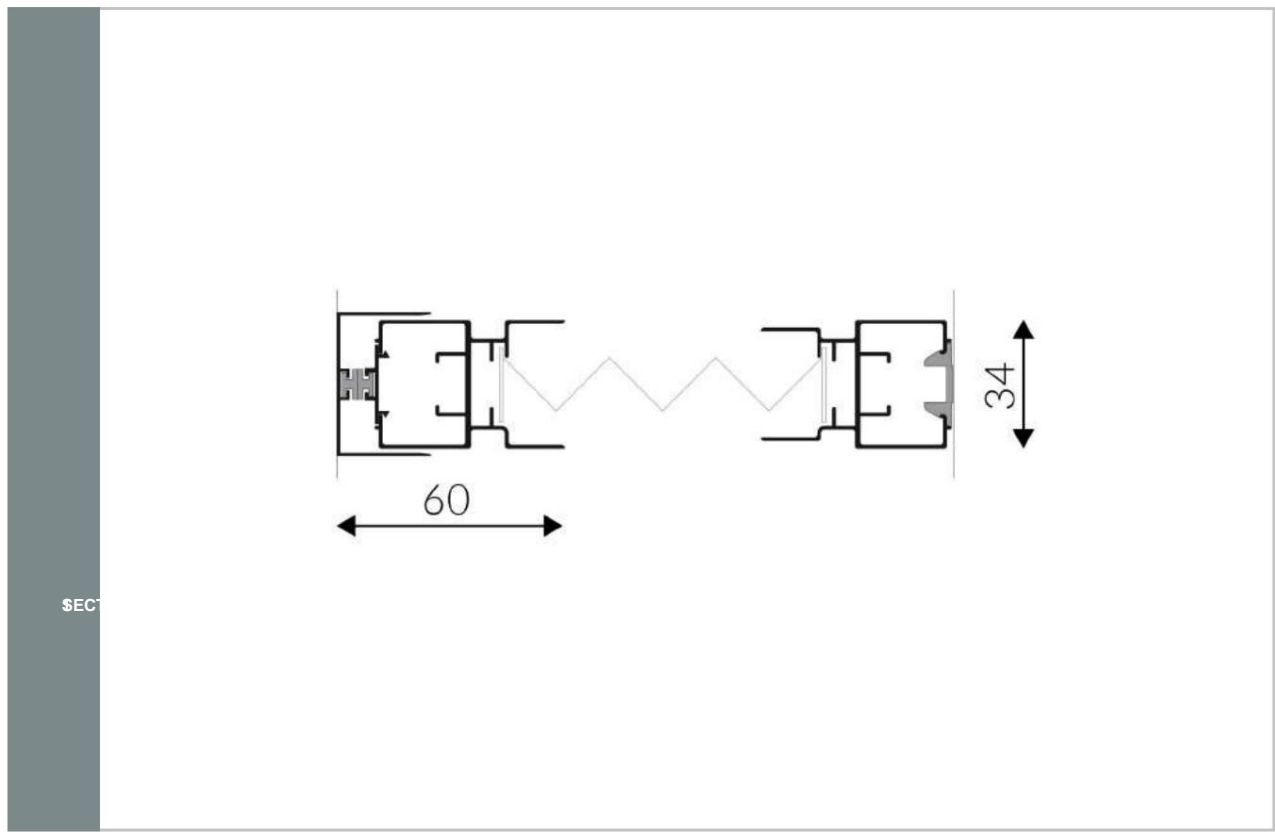



COLOUR RANGE

We make any colour from the RAL chart on request, lacquered, foiled, anodized and metallic, designed to integrate perfectly into all types of projects.



COLOR RELATIONSHIP



COLOR RELATIONSHIP

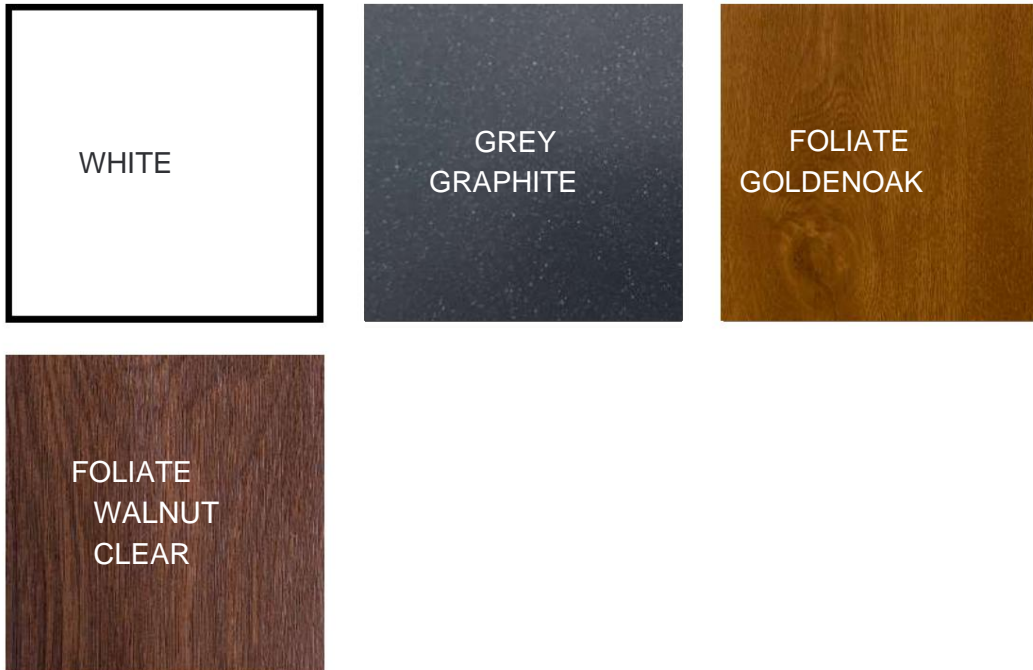

*Standard RAL: 1015, 3005, 5010, 5013, 6005, 6009, 7011, 7016, 7022, 7035, 8014, 8017, Matte Black, and Gloss Black.

*Renolit foils, minimum 60 ml or €60 increase *Anodized foils have a matte finish *The colours shown are

indicative and may vary from the actual colour due to possible defects in the image. If you need to know the exact colour tone or the full range, please do not hesitate to contact us.



08

FABRICS

MOSQUITO NET

Our fiberglass and aluminum fabrics for fixed or sliding installation systems effectively prevent the entry of insects, protecting you from pollen and pollution at the same time.

FIBERGLASS FABRIC



- Roll of 0.60 x 30 mm
- Roll of 0.80 x 30 mm
- Roll of 1.00 x 30 mm
- Roll of 1.20 x 30 mm
- Roll of 1.40 x 30 mm
- Roll of 1.50 x 30 mm
- Roll of 1.80 x 30 mm
- Roll of 2.40 x 30 mm

METALLIC FABRIC



- Roll of 1.00 x 30 mm
- Roll of 1.20 x 30 mm
- Roll of 1.50 x 30 mm



09

TECHNICAL DRAWINGS

MOSQUITO NETS

EXPLODED VIEWS

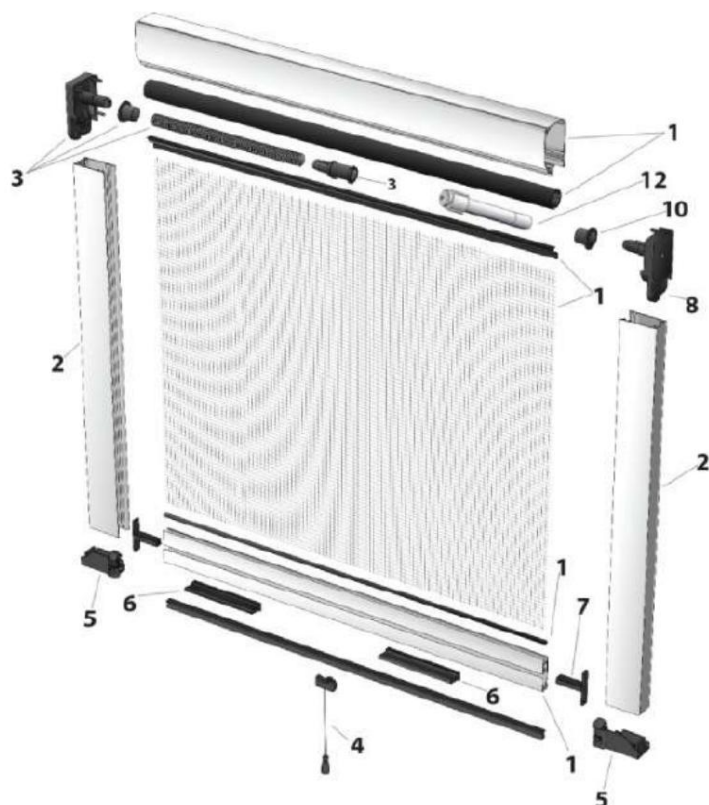

- | | |
|-----------------------------------|---------------------|
| ① 33, 35 OR 42 mm DRAWER | ⑥ FINISHING HANDLE |
| ② GUIDE WITH DOORMAT OR WINDPROOF | ⑦ FINISHING PLUG |
| ③ LONG PIER | ⑧ COUNTER-TESTERO |
| ④ PULL CORD | ⑨ SHAFT BUSHING |
| ⑤ BRAKE KIT | ⑩ RDS OR SLOW BRAKE |

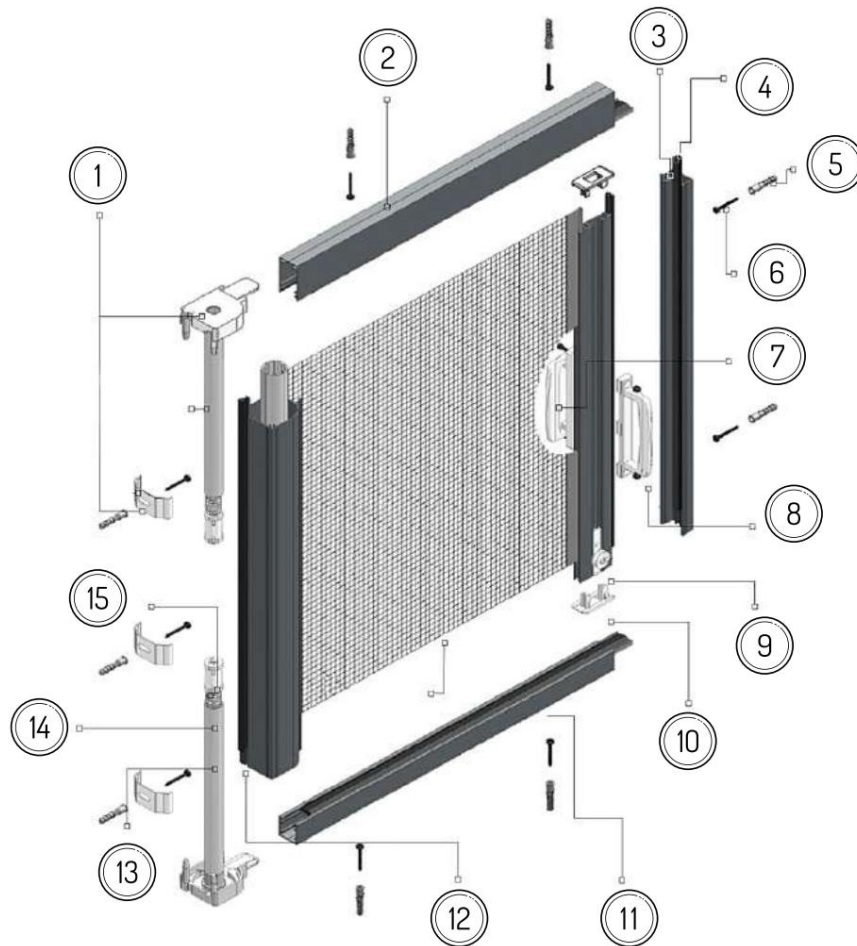

- | | |
|------------------------------|-------------------------------|
| ① REVERSE SPRING | ⑨ SLIDING ROLLER |
| ② SIDE GUIDE WITH DOORMAT | ⑩ TERMINAL PLUG |
| ③ MAGNETIC CLOSURE PROFILE | ⑪ INTERIOR GUIDE WITH DOORMAT |
| ④ BIPOLAR MAGNET DOOR CLOSER | ⑫ 5 x 10 mm DOORMAT |
| ⑤ FISHER 55 TACO | ⑬ PVC PIPE |
| ⑥ 35 x 30 mm SCREW | ⑭ DOCK |
| ⑦ EXTERNAL FOLDING HANDLE | ⑮ END PLUG SPRING |
| ⑧ FIXED INTERIOR LEVER | |

EXPLODED VIEWS

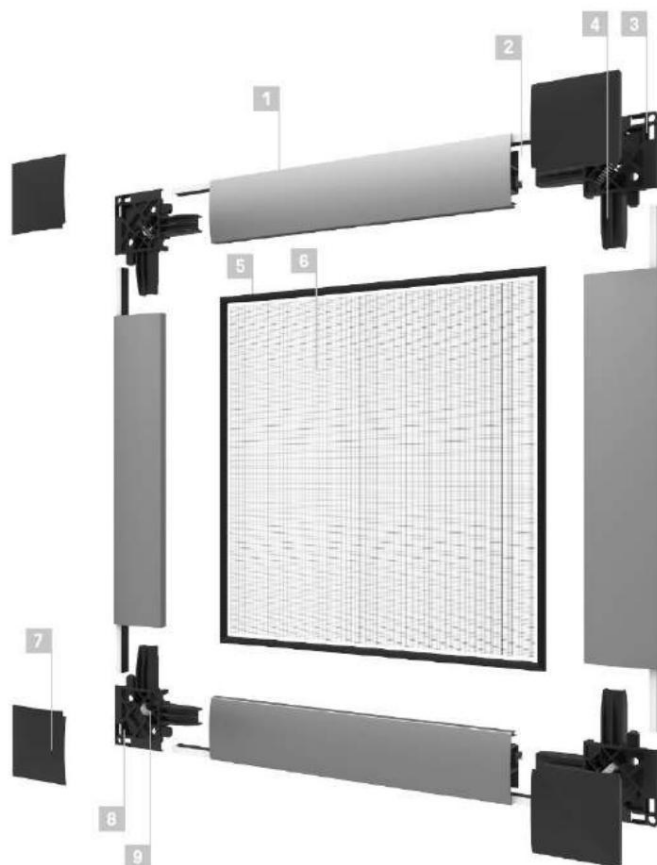

MOSC

- ① ADJUSTABLE PROFILE
- ② DOORMAT 5 X 9 mm
- ③ ADJUSTABLE UPPER BRACKET
- ④ UPPER COMPENSATORY SPRING
- ⑤ SOFT RUBBER WEATHERSTRIP
- ⑥ ANTI-MOSQUITO FABRIC
- ⑦ ADJUSTABLE SQUARE COVER
- ⑧ ADJUSTABLE LOWER BRACKET
- ⑨ REGULATOR WHEEL

EXPLODED VIEWS

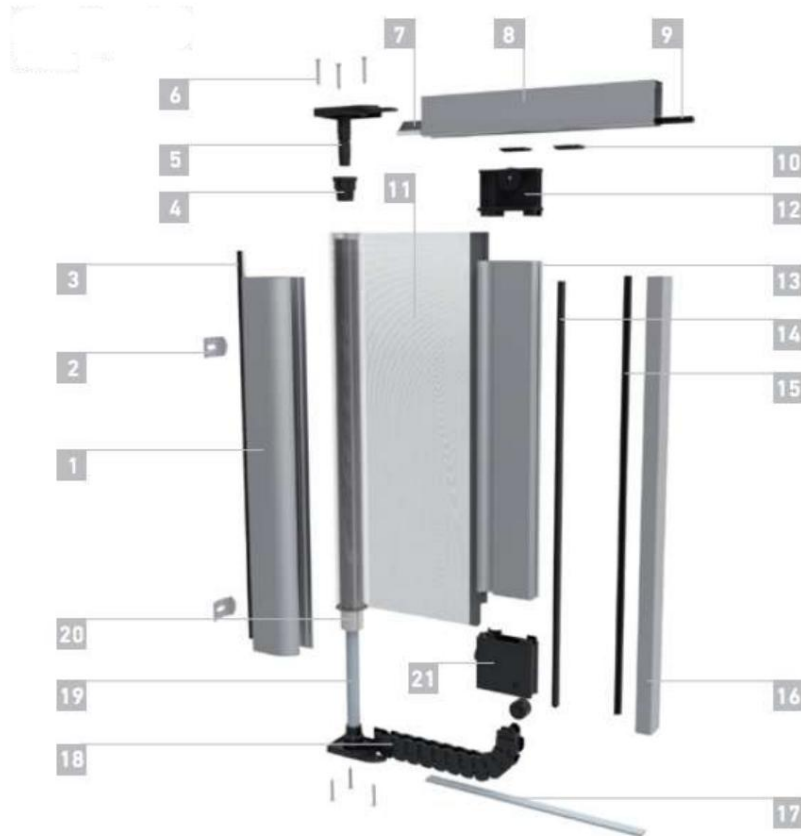

- | | | | |
|---|----------------------|---|-------------------------|
| ① | DRAWER | ⑫ | UPPER PLUG WITH BEARING |
| ② | MOUNTING CLIPS | ⑬ | SHOOTER PROFILE |
| ③ | DOORMAT 5.1 X 7.5 mm | ⑭ | MAGNETIC BAND + |
| ④ | BEARING | ⑮ | MAGNETIC BAND - |
| ⑤ | ENDPIECES | ⑯ | TUBE-SPRING ASSEMBLY |
| ⑥ | SCREWS | ⑰ | PVC LOWER GUIDE |
| ⑦ | DOORMAT 4.8 X 7.5 mm | ⑱ | CHAIN |
| ⑧ | TOP GUIDE | ⑲ | TUBE-SPRING ASSEMBLY |
| ⑨ | DOORMAT 5.1 X 7.5 mm | ⑳ | AXIS |
| ⑩ | TENSIONERS | ㉑ | LOWER PLUG WITH BEARING |
| ⑪ | ANTI-MOSQUITO FABRIC | | |

MOS
MOS

EXPLODED VIEWS

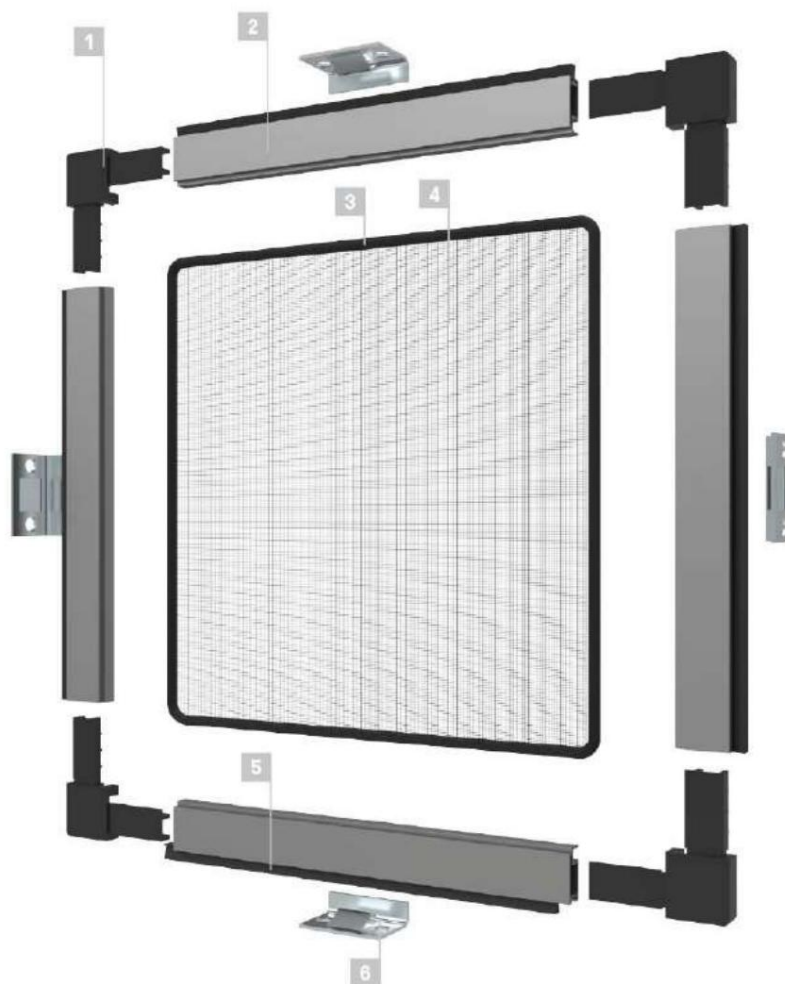

FIXE

- ① SQUAD
- ② FIXED MOSQUITO NET PROFILE
- ③ WEATHERSTRIP FABRIC FIXING
- ④ ANTI-MOSQUITO FABRIC
- ⑤ DOORMAT
- ⑥ CLIP

EXPLODED VIEWS

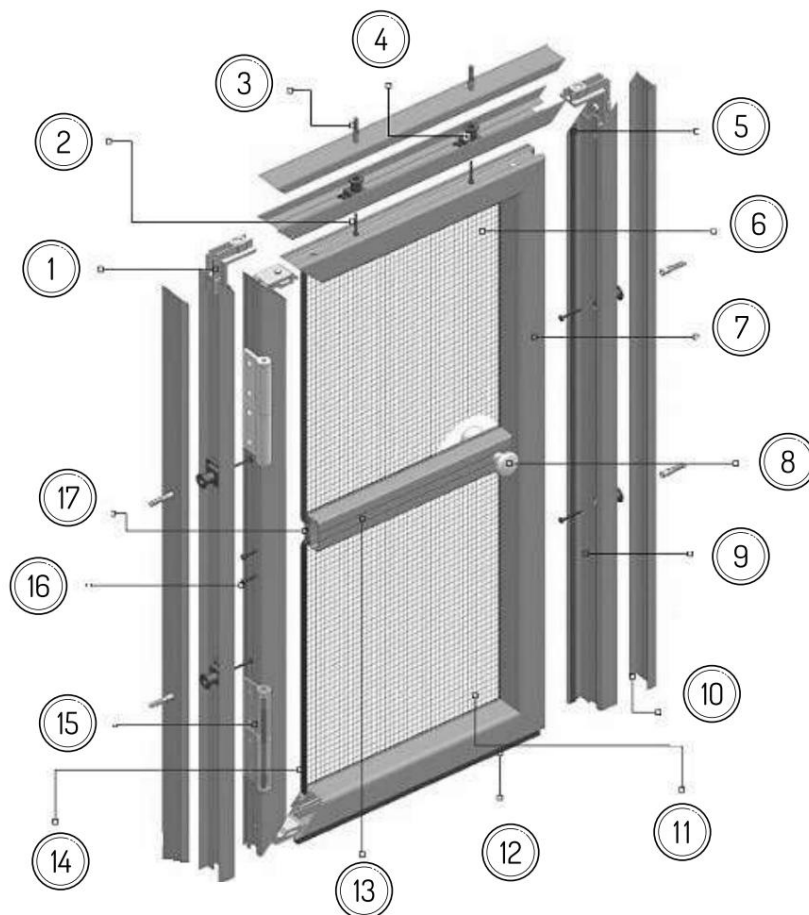

MOS

- | | |
|-----------------------|---------------------------------|
| ① ALUMINUM SQUARE | ⑩ COMPENSATOR PROFILE |
| ② 3.5 X 30 mm SCREW | ⑪ FIBERGLASS OR ALUMINUM FABRIC |
| ③ FISHER 55 TACO | ⑫ 6 x 14 mm DOORMAT |
| ④ REGULATOR TENSIONER | ⑬ INTERMEDIATE PROFILE |
| ⑤ DOOR CLOSING MAGNET | ⑭ RUBBER FABRIC FASTENER |
| ⑥ TISSUE | ⑮ HINGE WITH RETURN SPRING |
| ⑦ SHEET PROFILE | ⑯ 3.5 X 45 mm SCREW |
| ⑧ KNOB | ⑰ FLASHING PROFILE |
| ⑨ FRAME PROFILE | |



10

MEASUREMENT GUIDE

ROLL-UP AND PLEATED MOSQUITO NETS

First, we must take into account that both the pleated and roller mosquito nets must be installed in a gap with a space of at least 4.5 cm.

As for the roll-up mosquito net, to define its measurements, we must decide where we are going to install it. We recommend installing it inside , that is, between the blind and the window. If there is not enough space (4.5 cm), then we can install it outside .

ROLL-UP MOSQUITO NETS

①

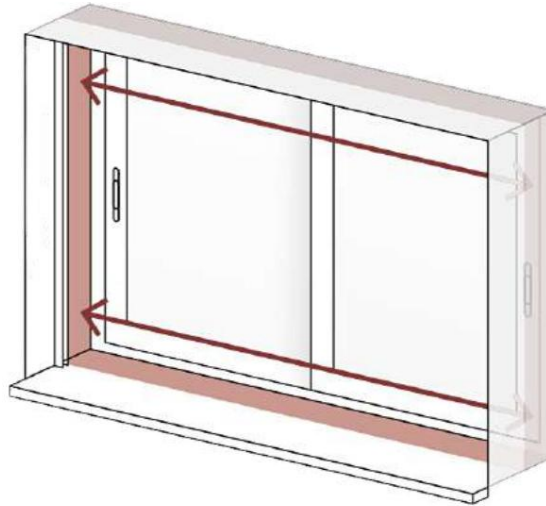

②

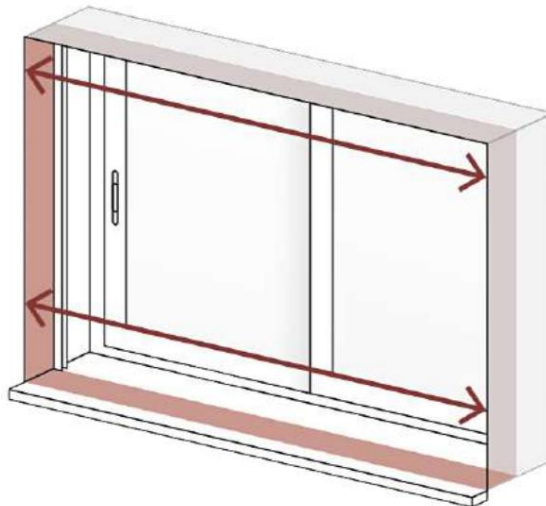

HOW

To measure the **width** of the mosquito net, we recommend measuring the window opening at two extreme points of the installation space we have chosen, **interior** (1) or **exterior** (2). If the two measurements do not match, take the smaller measurement as a reference.

ROLL-UP MOSQUITO NETS

①

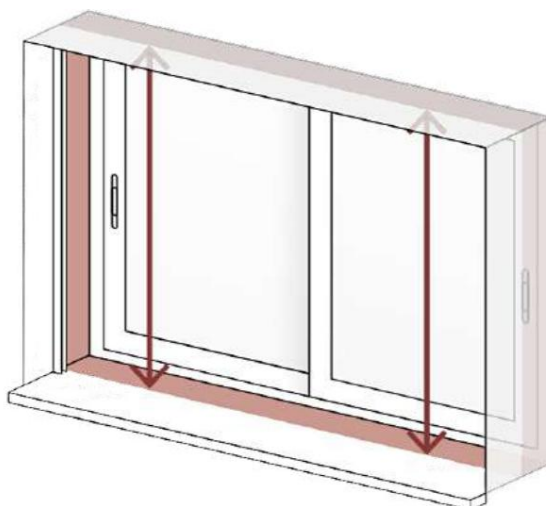

②

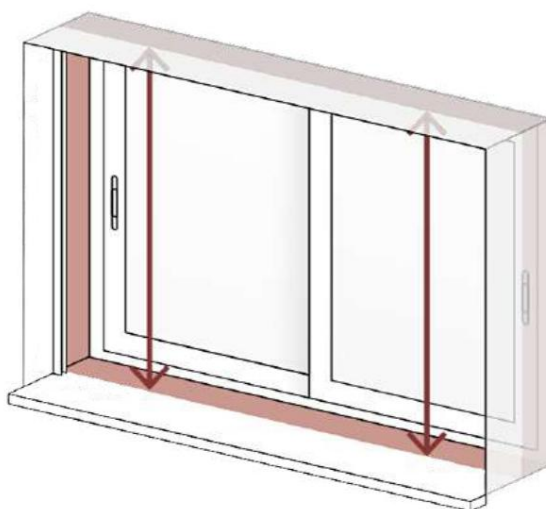

HOW

To measure the **height** of the mosquito net, we recommend measuring the window opening at two extreme points of the installation space we have chosen, **interior (1)** or **exterior (2)**. If the two measurements do not match, take the smaller measurement as a reference.

DRAWER MEASUREMENTS



If the mosquito net has a **width of up to 150 cm** and a **height of up to 180 cm**, its box will be 3.3 or 3.5 cm.

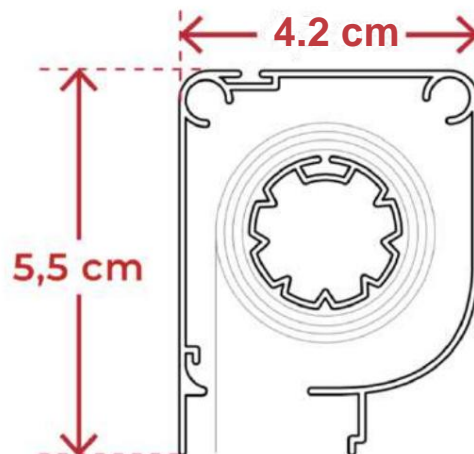

If the mosquito net has a **width greater than 150 cm** and a **height greater than 240 cm**, its box will be 4.2 cm.

RO

PLEATED MOSQUITO NETS

HOW

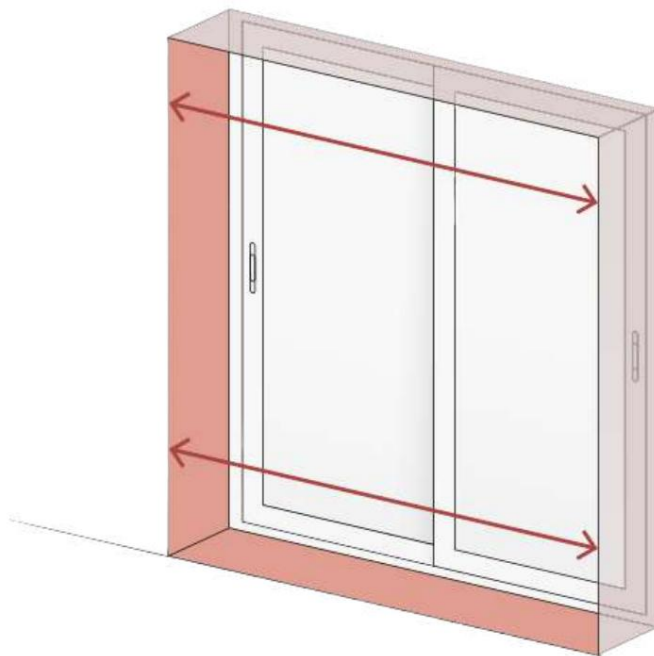

To measure the **width** of the mosquito net, we recommend measuring the window opening at two extreme points. If the two measurements do not match, use the smaller measurement as a reference.

PLEATED MOSQUITO NETS

HOW



To measure the **height** of the mosquito net, we recommend measuring the window opening at two extreme points. If the two measurements do not match, use the smaller measurement as a reference.



WE TAKE CARE OF EVEN HIM MINIMAL DETAIL

Being a manufacturer and formulator of PVC granules, PVC extrusion and aluminium profiling allows us to ensure supply in the value chain, and with a management system based on the ISO 9001 standard and together with highly technological manufacturing processes, we fulfil our commitment to offer you a quality and long-lasting product.



All our articles comply with the parameters of the European Standard in terms of conditions, wind resistance, water permeability, as well as the CE marking and have the respective certificates that endorse the corresponding standards and classifications.

This, together with a highly trained and qualified human team and an extensive commercial network, means that we can develop all kinds of solutions to adapt to market demands.





MOCAPLAS®

CONTACT

C / 5 , No. 24 - N birds 1 and 2
P ol. In d. Pic assent , 46220
(V ale n cia) ; Spain

TEL: +34961513841
FAX: +34961502755
info@mocaplas.com